



N8

2U Passive Cooler

PRODUCT SPECIFICATIONS

Table of Contents

1. PRODUCT DESCRIPTION	2
2. THERMAL PERFORMANCE CURVE.....	2
3. EP DRAWING	3
4. DM DRAWING	4
5. ROHS CERTIFICATE	5

Model Number: N8

- Intel® Ice Lake and Cooper Lake Server Processor Socket FCLGA 4189-4 / -5 (Socket P4 / P5 or P+)
- Passive Cooler for 2U Server and up

Overall Specification

Dimension	113 x 78 x 64 mm
Weight	500 g
Material	Aluminum Fin Stack; 5 Heatpipes with Vapor Chamber Base
Mounting Sets	Intel standard Anti-Tilt Rotating heat sink captive mounting sets
Package Carrier	Socket P4 Package Carrier is included
Thermal Grease	Shin-Etsu 7762 or Equivalent
TDP	Support CPU Power up to 250 Watts Heat Dissipation

Performance Chart: Passive Cooler N8 Thermal Resistance Thermal Resistance vs. Airflow

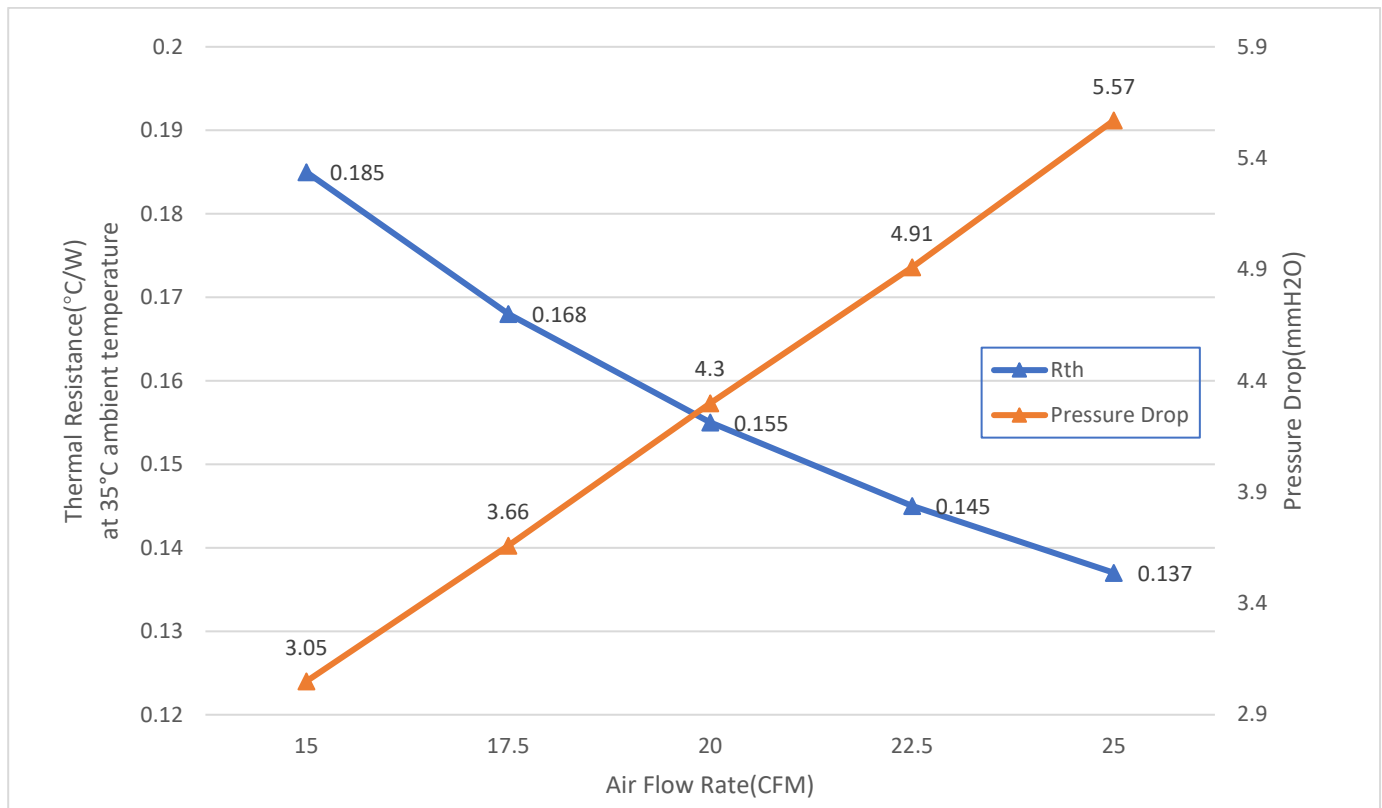

CONFIDENTIAL DOCUMENT

THIS DRAWING CONTAINS INFORMATION PROPRIETARY TO DYNATRON CORPORATION AND DYNAEON INDUSTRIAL CO., LTD. ANY REPRODUCTION, DISCLOSURE, OR USE OF THIS DRAWING IS EXPRESSLY PROHIBITED EXCEPT AS DYNATRON CORPORATION AND DYNAEON INDUSTRIAL CO., LTD. MAY OTHERWISE AGREE TO IN WRITING.

ASSEMBLY PARTS

REV#	DESCRIPTION	CHECKER	DATE
0.0	INITIAL RELEASE	LANG	08/20/2020

WHOLE SET OF HEATSINK

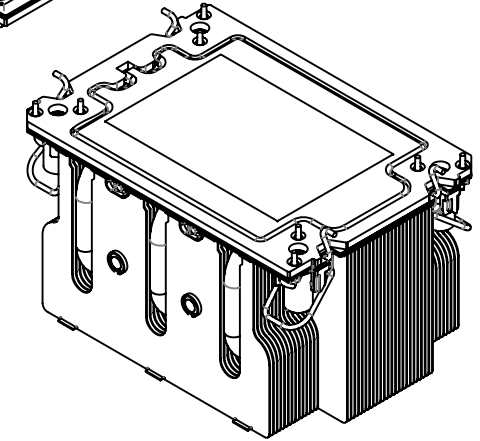
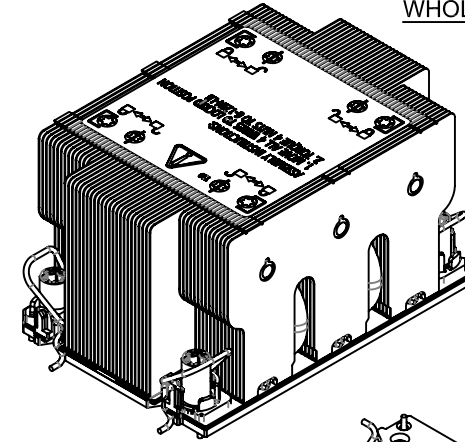
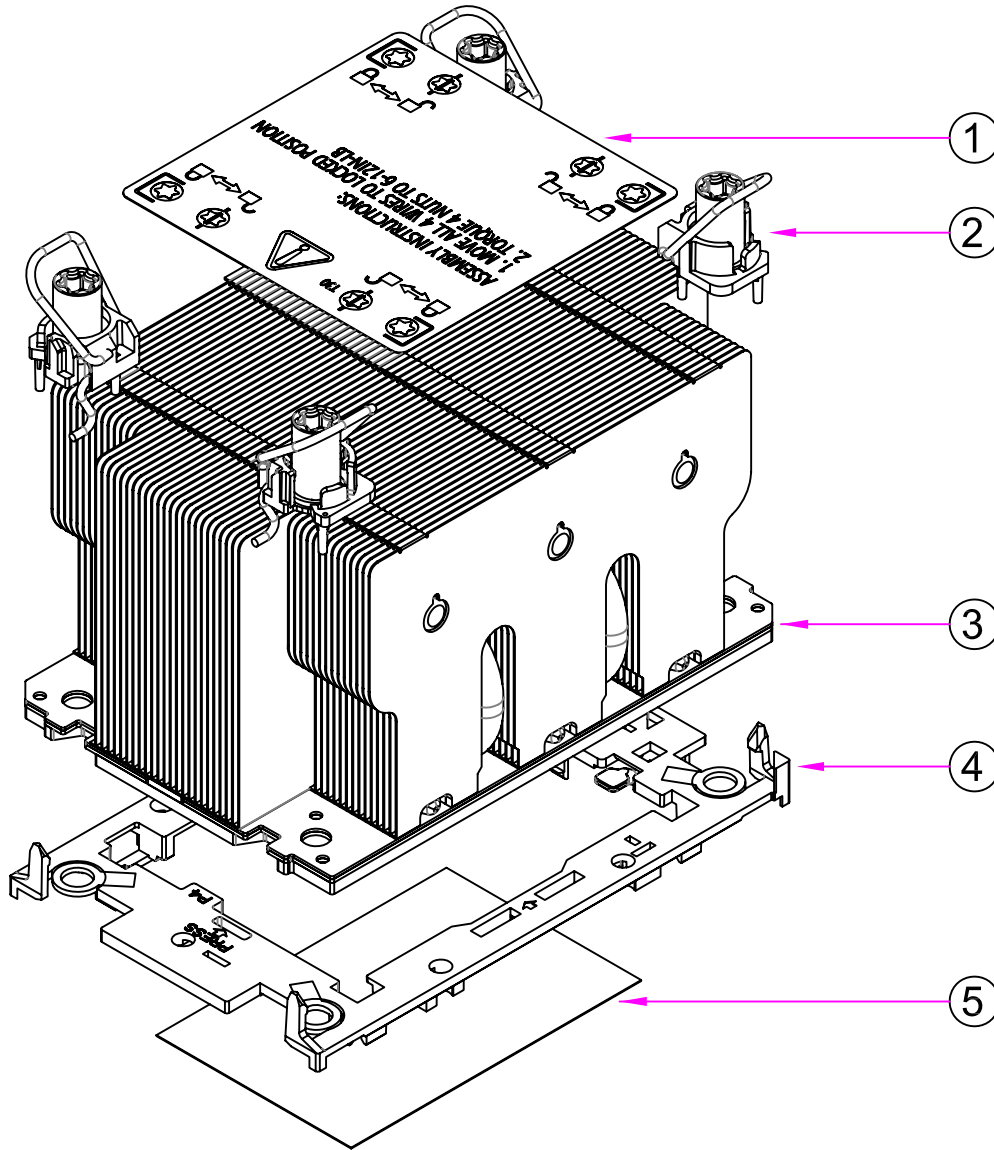

NOTES:

1. THE FIGURE IS FOR REFERENCE ONLY, AND NOT FOR SCALE
2. OVERALL DIMENSION : 113 x 78 x 64 mm
3. OVERALL WEIGHT : 500 g

ITEM#	DESCRIPTION	MATERIAL	QTY.
5	THERMAL GREASE, PRE-PRINTED	SHIN-ETSU 7762	1
4	INTEL PACKAGE CARRIER (P4 VERSION)	PLASTIC	1
3	HEATSINK, with STACKED FINS	ALUMINUM FIN STACK VAPOR CHAMBER BASE (5 x) COPPER HEAT PIPES	1
2	ANTI-TILT ROTATING WIRE ASSEMBLY SET	PLASTIC NUT AND CAPTIVATION STEEL ROTATING WIRE	4
1	MOUNTING INSTRUCTION LABEL	PLASTIC	1

DATE	NAME	 DYNATRON CORPORATION
DRAWN 08/20/2020	Engr	
CHECKED 08/20/2020	LANG	
ENG. APPR.		
MFG. APPR.		
G.A.		
COMMENTS:		

TITLE:	2U Passive Cooler N8	
	BOM & Exploded Assembly Drawing	
DWG. No:	DYN-EP-N8	REV 0.0

REV#	DESCRIPTION	CHECKER	DATE
0.0	INITIAL RELEASE	LANG	08/20/2020

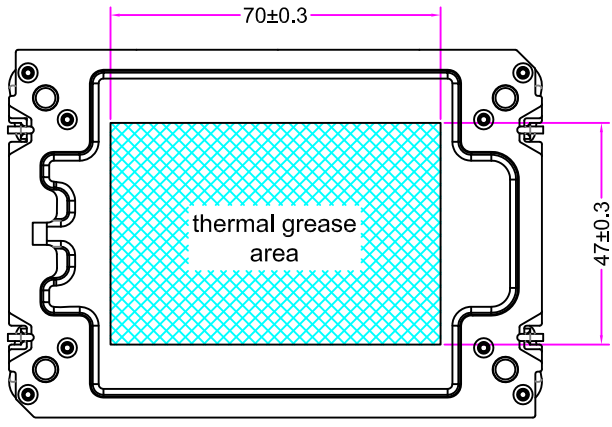
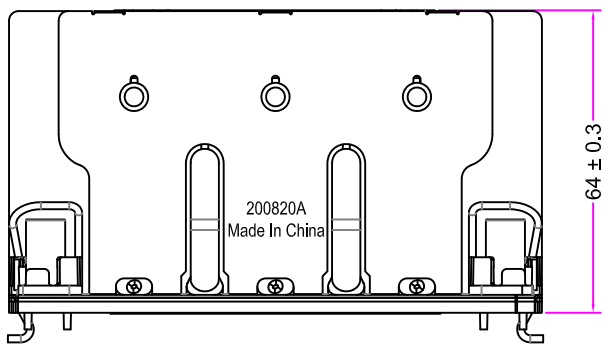
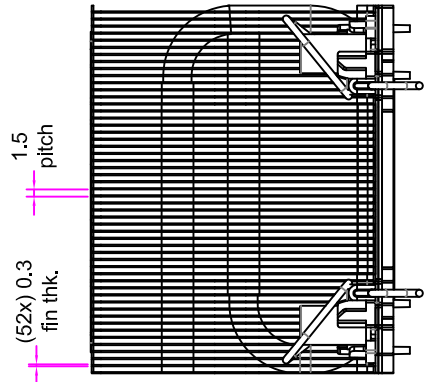
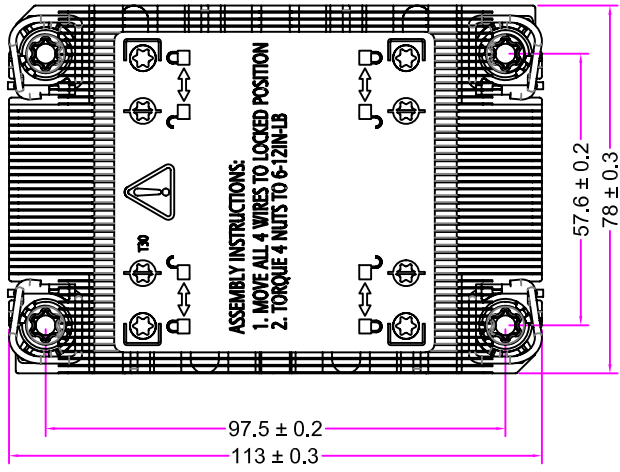
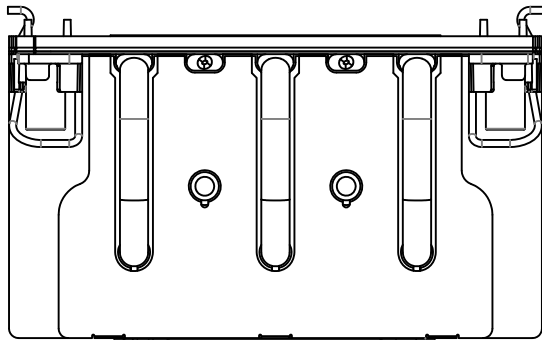

	NAME	DATE
DRAWN BY	enr	08/20/2020
CHECKED BY	LANG	08/20/2020
ENG. APPROVED		
MFG. APPROVED	-	-



DYNATRON CORPORATION

TOP MOTOR

TITLE: **2U Passive Cooler N8**
Overall Dimension Drawing

CONFIDENTIAL DOCUMENT
THIS DRAWING CONTAINS INFORMATION PROPRIETARY TO DYNATRON CORPORATION AND DYNAEON INDUSTRIAL CO., LTD. ANY REPRODUCTION, DISCLOSURE, OR USE OF THIS DRAWING IS EXPRESSLY PROHIBITED EXCEPT AS DYNATRON CORPORATION AND DYNAEON INDUSTRIAL CO., LTD. MAY OTHERWISE AGREE TO IN WRITING.

VIEW	
UNITS	MM

DWG. No: **DYN-DM-N8**

REV. **0.0**



Certificate of Environment Protection

環保證明書

Customer: 客戶名稱:	Company: _____ Address: _____ Phone Number: ____ - ____ - _____
Issue Date:	08 / 20 / 2020
Product Model Number:	N8
<p> Dynatron Corporation hereby declares and certifies that all components manufactured are RoHS compliant according to the definitions and restrictions given by the European Union's Restriction (Directive 2002/95/EC) (Decision 2011/65/EU) RoHS 2, on the restriction of the use of certain Hazardous Substances in the electrical and electronic equipment. Also, compliance to the most recent list of substances on the REACH candidate list. </p> <p> Number of substances on the Candidate List: 168 (last updated: 17/12/2015) </p> <p> No exemptions are claimed in order for the part to be compliant with the RoHS directive. </p> <p> Dynatron Corporation / 政久興業股份有限公司 證明所有產品, 零件 (包括附屬品, 包裝類) 之環境管理物質完全符合 RoHS, WEEE, 及該環保標準之規定, 並承諾遵循以上之證明。 </p> <div style="text-align: right; margin-top: 20px;"> <p> Dynatron Corporation. 33200 Western Ave, Union City, CA 94587 www.Dynatron-corp.com </p> </div> <p style="margin-top: 20px;"> Title (職務): _____ ASSISTANT-MANAGER _____ </p> <p style="margin-top: 10px;"> Signature (簽字): _____ <i>Alan Lee</i> _____ </p> <p style="text-align: right; margin-top: 10px;"> Date: 08 / 20 / 2020 </p>	

